

FØROYSKT



45 minuttir







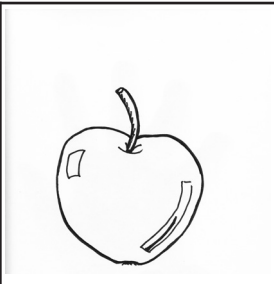
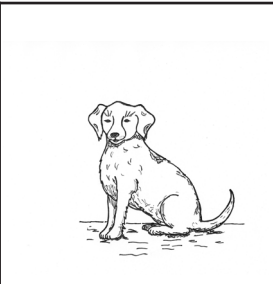

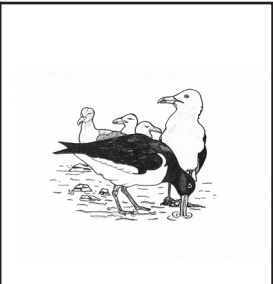
Navn:	Flokkur:
Skúli:	Lærari:

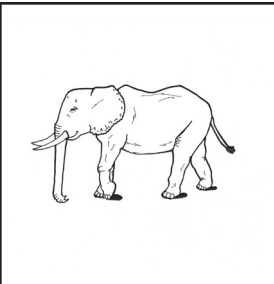

Svarini verða skrivað á uppgávuarkið. Tú kanst skriva við blýanti.

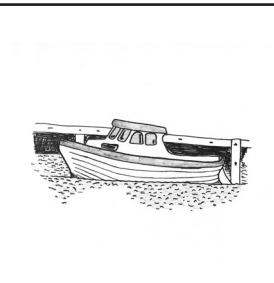
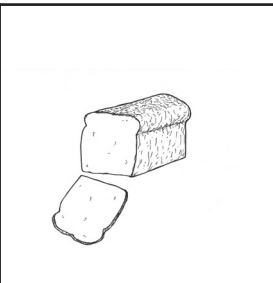
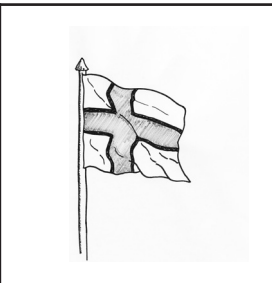

Set X við röttu myndina



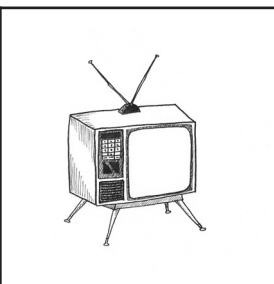
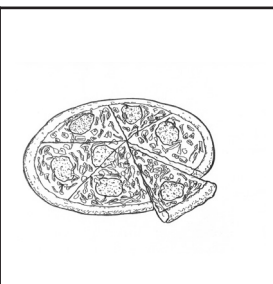

víndrúvur				
	<input type="checkbox"/>	<input type="checkbox"/>	<input type="checkbox"/>	<input type="checkbox"/>

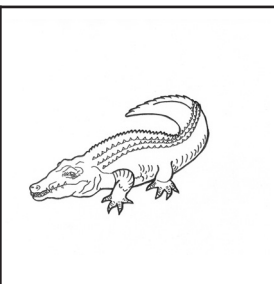

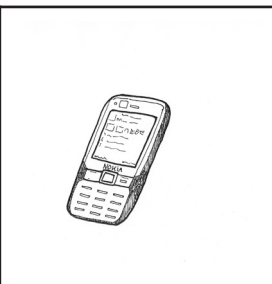
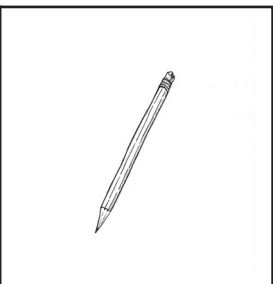

súkkla				
	<input type="checkbox"/>	<input type="checkbox"/>	<input type="checkbox"/>	<input type="checkbox"/>



breyð				
	<input type="checkbox"/>	<input type="checkbox"/>	<input type="checkbox"/>	<input type="checkbox"/>



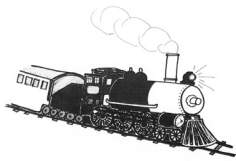

sjónvarp				
	<input type="checkbox"/>	<input type="checkbox"/>	<input type="checkbox"/>	<input type="checkbox"/>



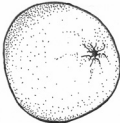

kavamaður				
	<input type="checkbox"/>	<input type="checkbox"/>	<input type="checkbox"/>	<input type="checkbox"/>

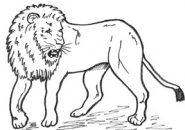
traktorur				
	<input type="checkbox"/>	<input type="checkbox"/>	<input type="checkbox"/>	<input type="checkbox"/>

kráka				
	<input type="checkbox"/>	<input type="checkbox"/>	<input type="checkbox"/>	<input type="checkbox"/>

jólatræ				
	<input type="checkbox"/>	<input type="checkbox"/>	<input type="checkbox"/>	<input type="checkbox"/>

hundur				
	<input type="checkbox"/>	<input type="checkbox"/>	<input type="checkbox"/>	<input type="checkbox"/>

blýantur				
	<input type="checkbox"/>	<input type="checkbox"/>	<input type="checkbox"/>	<input type="checkbox"/>

Les setningarnar á síðuni og skriva rætt tal við myndirnar á síðu 5!

1. Appelsin er ein frukt
2. Bøndur koyra ofta traktor
3. Tá ið beiggi fylti, fingur vit lagkøku
4. Vit brúka blýant í skúlanum
5. Krokodillan bítur sera fast
6. Nógvir fuglar koma til Føroya um várið
7. Abbi dugir væl at baka breyð
8. Eg ynski mær eina nýggja fartelesfon
9. Giraffar hana langan háls
10. Vit hava keypt nýggjan bil

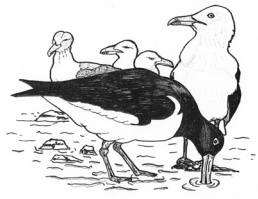

6

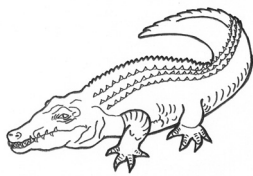
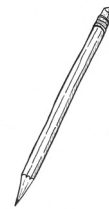
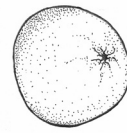
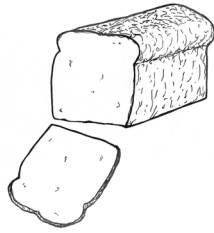

Les setningarnar á síðuni og skriva rætt tal við myndirnar á síðu 7!

1. Mær dámar væl at spæla teldu
2. Eg fari ofta súkklutúr um summarið
3. Hvítabjarnir búa í Grønlandi
4. Sitrónir eru súrar at bíta í
5. Eg eigi ein fótbold
6. Kettan hjá okkum hevur kettlingar
7. Systir mín dugir væl at svimja
8. Tú kanst koyra við toki í Danmark
9. Vit hava tikið upp epli
10. Sjónvarpið hjá okkum er í ólagi

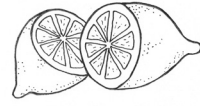
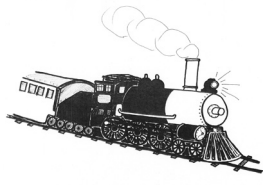

Set X við röttu myndina

1. Djórið stendur á landi
Tað hevur langan hala
Tað hevur ljóst skinn
Tað hevur ein unga hjá sær

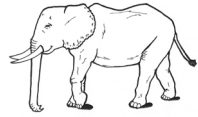
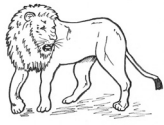

2. Luturin er fýrkantaður
Luturin er oftast inni
Luturin verður brúktur at spæla við
Ofta eru 52 í einum setti



3. Tú skalt finna eina frukt
Hon er ikki avlong
Hon er rund
Hon er appelsingul

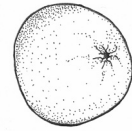

4. Tú skalt finna eitt akfar
Tað hevur motor
Pláss er fyri fleiri fólkkum
Akfarið kann ikki koyra í Føroyum

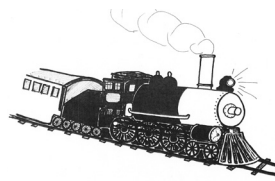

5. Tað er ein fuglur
Fuglurin er einsamallur á myndini
Hann hevur spískt nev
Hann er svartur

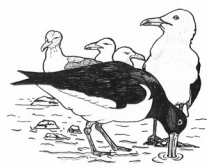
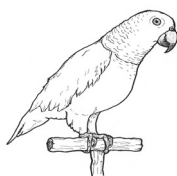



Set kross við rætt svar

	Tað síggi eg á myndini	Tað veit eg ikki
Drongurin er í stríputari blusu		
Gentan eitur Rannvá		
Drongurin er troyttur		
Børnini eru úti		
Børnini fletta bein		
Børnini eru í Havn		
Gentan er í gummistivlum		
Gentan er 10 ár		
Drongurin hevur svart hár		
Ein stigi liggur aftan fyri børnini		



Set kross við rætt svar

	Tað síggi eg á myndini	Tað veit eg ikki
Trý börn eru á myndini		
Barnið til hægri er í hvítum jakka		
Börnini ganga í 4. flokki		
Börnini eru í Vági		
Gentan til vinstri er 11 ár		
Tað er ólavsøka		
Skuggarnir av börnunum síggjast í hylinum		
Gentan í miðjuni hefur turriklæði		
Barnið til hægri eitur Lisa		
Barnið til hægri er í bláum buksum		

Hvat orð heyrir ikki við her?

Set ring um rætta svarið og skriva tað á reglurnar

súrepli – appilsin – banan – melón – bilur – ananas _____

tallerkur – posi – koppur – glas – kannu – krúss _____

song – stólur – borð – bók – skáp – sofa _____

bilur – bussur – tok – knívur – súkkla – bátur _____

bilførari – lækni – skipari – lærari – klokka – námsfrøðingur _____

telefon - posi – taska – skúlataska – kuffert – ryggsekkur _____

fótur – lær – armur – oyra – hálsur – gras _____

blusa – buksur – hosur – mynd – hógva – troyggja _____

glaður – bilsin – gaffil – kløkk – óð – keddur _____

sodavatn – kaffi – dagur – saft – mjólk – te _____

Finn í minsta lagi 10 orð í kassanum og set ring um tey.

Orðini standa tvørturum og niðureftir.

B	D	U	N	N	A	V
I	O	S	Ø	Ð	A	K
L	Ú	S	S	T	N	E
U	K	N	B	A	E	T
R	U	H	O	S	A	T
H	S	Ú	K	K	L	A
K	R	Á	K	A	M	T

Skriva orðini her:

Brot úr bókini “Vikarurin – tey í 5. B”.

Helle Thede Johansen hevur skrivað. (BFL, 2010)

Børnini í 5. B eru á veg heim úr skúla. Tey koma fyrst til húsini hjá Barbaru.

“Ná, koma tit inn við, ella hvat?” spyr Barbara og hyggur spyrjandi at Annu og Jóhannu.

Tær ætla sær óivað at spæla Sims ella at kjatta við onkran á Arto¹, hugsar Bergur við sær sjálvum. Barbara hevur bæði teldu, sjónvarp og Wii inni á kamarinum, so har dámar gentunum væl at samlast.

“Vit síggjast”, rópar Barbara og vendir sær í hurðini, meðan Jóhanna og Anna fara innum. “Minst nú til at gera skúlaþingini, Bergur!” leggur hon afturat, áðrenn hon gnisandi² skundar sær inn og klamsar hurðina.

“Áh, hon skal altíð arga,” snerkir Bergur. “Nú spælir hon aftur stórasystir.”

“Ha, ha. Ja, gott eg ikki havi systkin,” flennir Pætur, “ella hálv systkin. Men hon er jú hvørki. Gloym hana!”

Barbara og Bergur eru fødd sama dag, men Barbara er seks tímar eldri, og tað elskar hon at minna hann á. Mammur teirra komu at kennast á føðideildini³, og síðan tá hava familjur teirra verið nógv saman, so tað kennist næstan, sum tey eru systkin.

“Nú? Fara vit at sparka, ella hvat?” spyr Pætur, meðan hann letst at dribla⁴ og hyggur kannandi at Bergi.

Bergur orkar ikki líka væl sum Pætur, og als ikki so nógv sum hann sjálvur vil, men hann *vil* ikki vera ein, ið skal ansast eftir, tí at hann hevur havt krabbamein.

“Jú, kom og sparka,” svarar Bergur, ”men lat meg líka fara heim við taskuni og lova Ronaldo út fyrst.”

“Jepp, vinurin,” smílist Pætur. Hann veit, at Ronaldo, hundurin hjá Bergi, altíð kemur í fyrstu røð⁵ hjá honum. “Eg fari eisini heim við taskuni fyrst. Tekur tú bólt við?”

1 kjattprogramm á internetinum.

2 flennandi.

3 deildin á sjúkrahúsinum, har børnini verða fødd.

4 letur, sum hann driblar.

5 Bergur hugsar altíð um hundin áðrenn nakað annað.

“Ja, eg taki bólt við. Síggjast um 5 minuttir.”

Familjan hjá Bergi býr í einum lítlum, svörtum húsum við flagtaki⁶. Bergur hefur ofta hoyrt fólk siga, at tað er so hugnaligt hjá teimum. Bergur hefur ikki hugsað so nógv um tað. Tað er jú bara “heima”. Honum dámar tó væl, at mamman er heima, tá ið hann kemur úr skúla. Tá hefur hon mangan kakao og bollar til hansara.

Beint nú er bara Ronaldo heima. Hann hoyrist eisini, nú hann kennist við fótafetini hjá Bergi. Hann hvínur av gleði, og tá ið Bergur letur hurðin upp, kemur ein gulbrún rakett rúkandi út millum beinini á Bergi.

“Hey, besti vinur mín. Ert tú so glaður at síggja meg?” spyr Bergur, meðan hann hýkur niður at kína hundinum, sum smoyggir sær rundan um hann.

Set kross í rætta puntin

	ja	nei
Jóhanna og Anna fara inn við Barbaru		
Arto er bók, sum 5. flokkur brúkar í skúlanum		
Barbara eigur Playstation 3 í kamarinum		
At gnisa merkir at flenna		
Bergur fer inn við Barbaru		
Barbara og Bergur eru systkin		
Barbara er 6 tímar eldri enn Bergur		
Mamma Barbaru og mamma Berg kennast av føðideildini		
Familjurnar hjá Barbaru og Bergi eru nógv saman		
Føðideildin er kantinan á sjúkrahúsinum		

Set kross í rætta puntin

	ja	nei
Pætur letst at dribla		
Bergur hevur havt krabbamein		
Bergur og Pætur avtala at fara at sparka		
Teir ætla at taka taskuna við á vøllin		
Ronaldo er ein hestur		
Bergur og Pætur avtala at hittast um fimm minuttir		
Bergur býr í einum reyðum húsum		
Húsini hjá Bergi hava flagtak		
Mamman gevur ofta Bergi smákøkur og kaffi		
Ronaldo er glaður, tá ið Bergur kemur heim		

Krossorð

Les setningarnar og skriva svarið í krossorðagátuna.

Tvörturum →

2. Fuglur, ið sigur krá krá
4. Hon er góð, tá ið kavi er

Niðureftir ↓

1. Seyður (kvenndýrið)
3. Djór, ið sigur mjav
5. Gott at hava, um hurðin er læst

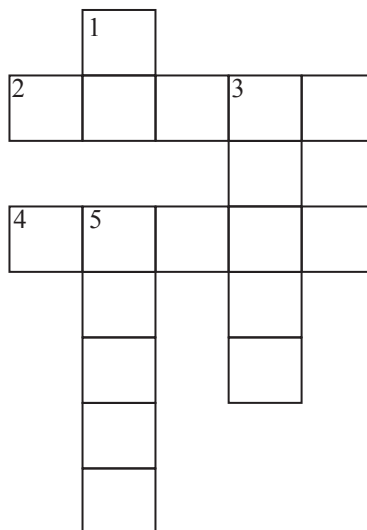

Tvörturum →

1. Ikki omma, men _____
3. Vit kóka epli í henni
5. Dreingjanavn

Niðureftir ↓

2. Vit brúka ein _____ at skriva við
4. Eitt djór, sum dámar væl banan
6. Ikki fyrr, men _____

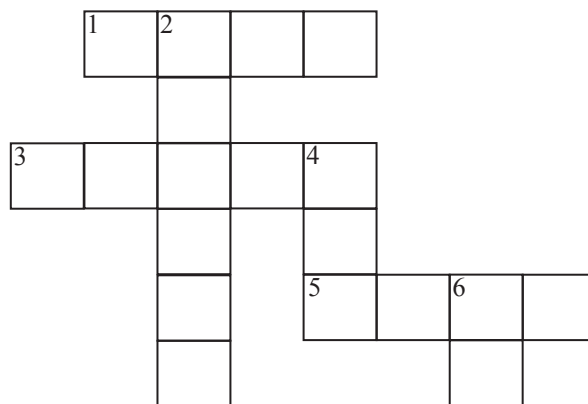

Tvørturum →

2. Kópahvølpur eitur _____
5. Tá ið vit detta, fáa vit _____

Niðureftir ↓

1. Á húkinum, tá ið vit fiska
3. Vit gerast glað, tá ið _____ skínur
4. Ikki lítil, men _____

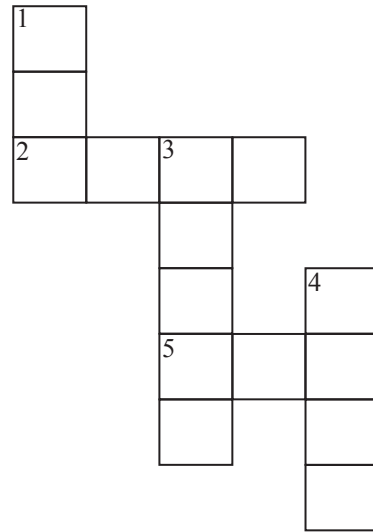

Tvørturum →

2. Ikki eg, men _____
3. Apum dámar væl _____
4. Klokka

Niðureftir ↓

1. Vit dansa um _____ á jólum
2. Tjóðfuglur Føroya

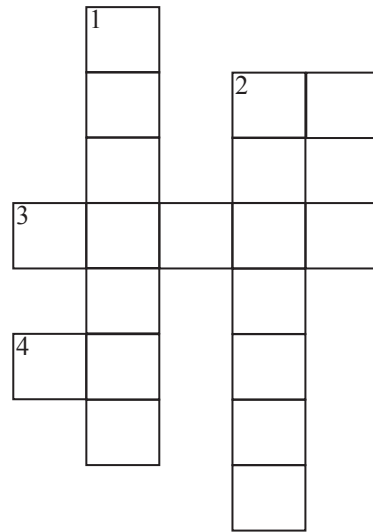

Ger eftir forskriftini

vinstra
ovast

høgra
ovast

vinstra
niðast

høgra
niðast

- Set ein kross í mittasta puntin
- Set ein kross í ovasta punt í uttasta teigin til høgru
- Set ein kross næstniðast í uttasta teigin til vinstru
- Set ein kross næstovast í næstuttasta teigin til høgru
- Set ein kross niðast í næstuttasta teigin til vinstru



Prent: Føroyaprent